

SURGE ARRESTER: JENSEN 8266 5500 L

(Document No 9250)

Mechanical characteristics:

(all dimensions in mm)

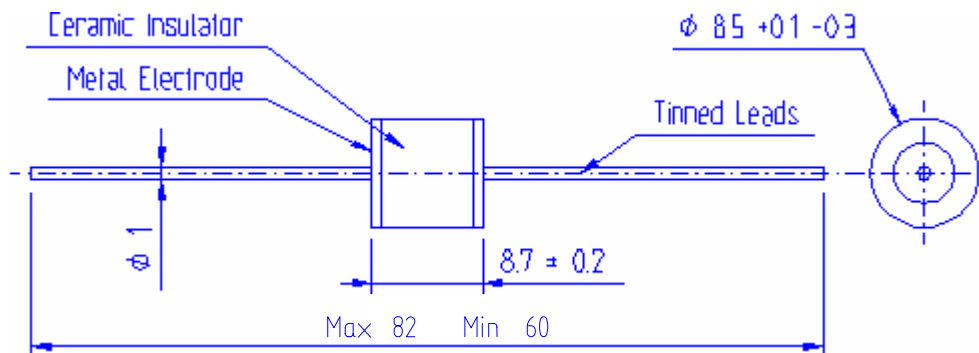

Specifications:

- | | |
|--|-----------------------|
| - DC breakdown voltage (@500 V/s) | 5500 V nom. +20% -15% |
| - Impulse breakdown (@7.5 kV/ μ s) | 8000 V max. |
| - Insulation resistance (@250 VDC) | 10 G Ohm min. |
| - Capacitance | 1 pF max. |
| - Arc voltage (@5A min.) | 20 V typ. |
| - Operating temperature range | -40°C to 125°C |
| - Storage temperature range | -65°C to 125°C |
| - Surge life with 5 kA surge (8/20 μ s) after 10 shots: DC breakdown voltage > 4.4 kV. | |
| - UL 1414 approved | |

Environmental testing per IEC60068-2:

Operational:

- Low air pressure: IEC60068-2-13 test M, temp. 55°C, time 0.5, pressure 600 hPa.

Non-Operational:

- Cold: IEC60068-2-1 test Ab, 40°C, 96 h.
- Dry heat: IEC60068-2-2 test Bb, 100°C, 96 h.
- Damp heat, steady state: IEC60068-2-30 test Ca, 21 days, 40°C, RH 93%.
- Rapid change of temperature: IEC60068-2-14 test Na, upper temp 100°C, lower temp -40°C, 5 cycles.
- Vibration: IEC60068-2-6 test Fc, 10-55 Hz, 30 min per axis, double amplitude 0.70 min.
- Shock test: IEC60068-2-27 test Ea, 30 g, 11 ms, half sine pulse.
- Solderability: IEC60068-2-20 test Ta, method 1, 235°C, 2 s, aging.
- Resistance to soldering heat: IEC60068-2-20 test Tb, method 1A, 260°C, 5 s.
- Robustness of terminations: IEC- 60068-2-21 test Ua1 (tensile), Ua2 (thrust), Ub (bending) and Uc (torsion).